

HLV-2000



Instruction & Operations Manual

Content

Chapter		page
1.	Certificate of conformity	3
2.	Introduction	4
3.	Safety instructions	5
4.	Electrical connections	6
5.	Warranty	7
6.	Front panel operation	8
7.	Protection circuits	9
8.	Receive-Transmit switching	10
9.	Remote control	11
10.	Cooling technique	12
11.	Block diagram	13
12.	Adjustment of protection thresholds	14
13.	Control circuit schematic	15
14.	tbt	

1. CERTIFICATE OF CONFORMITY

Hereby we declare that the following products:

Linear amplifier HLV-250, HLV-350, HLV-400, HLV-550, HLV-800, HLV-950, HLV-1000, HLV-1100, HLV-1950 and HLV-2000

fully meet all technical specifications according to EU directives as:

06/95/EC, 2004/108/EC and 99/5/EC:

EN 301 783-1 V1.1.1 (2000-09), EN 301 783-2 V1.1.1 (2000-09)

EN 301 489-1 V1.6.1 (2005-09), EN 301 489-15 V1.2.1 (2002-08)

EN 60950-1: 2006

All necessary test procedures have been successfully passed



Manufacturer and authorized representative:

**BEKO-ELEKTRONIK
Am Längenmoosgraben 1a
D-85221 Dachau
GERMANY**

This declaration has been accomplished under unique responsibility of the manufacturer

BEKO-Elektronik
Bernhard Korte
Am Längenmoosgraben 1a

Dachau, den 1.04.2012

2. Introduction

Congratulations for purchasing your new BEKO linear amplifier. You have purchased a quality product, individually built to the highest standards, and one that will last you a lifetime. Please take a few minutes to read this instruction manual and then store it in a safe place for future reference. Finally, it's up to you to insure that all components used in your system such as cables, connectors, preamps and coaxial relays can handle this amplifier's power level.

The HLV-2000 is a solid state MOSFET VHF-amplifier covering the 144 – 148 MHz frequency range with a selectable gain of 16-23 db. The internal modulated power limit is kept to 2200 watts. It's design is based on Freescale's rf transistor MRFE6VP61K25H. Optimized output matching including h3-phase compensation and elliptic low pass filter ensure best efficiency, highest 1dB compression and high spectral purity. It is essential that the driving source has a narrow phase noise and high spectral purity. The output signal of an amplifier can't be better than it's input signal.

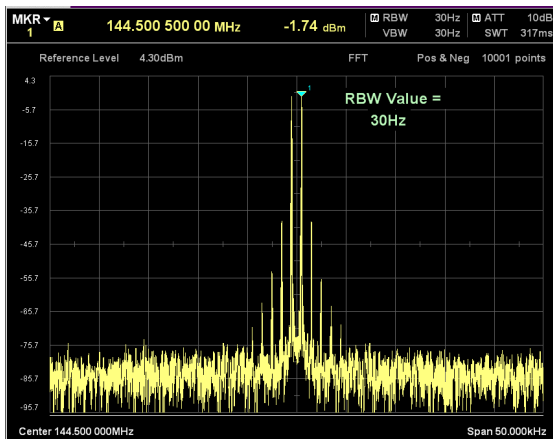

Intermodulation products @ 1,0 kW PEP

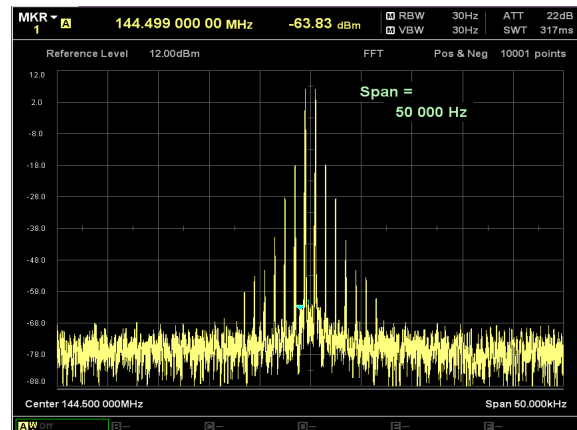

Intermodulation products @ 2,0 kW PEP

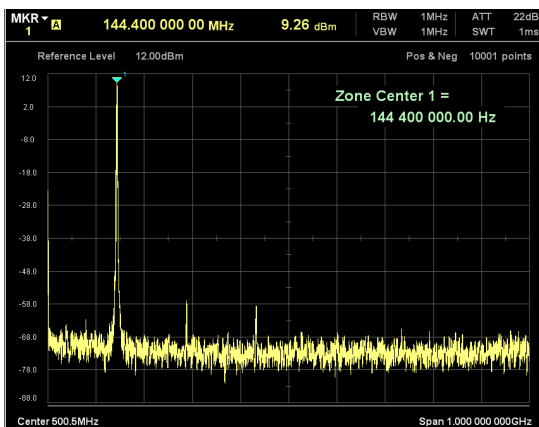

Harmonic attenuation @ 2 kW CW

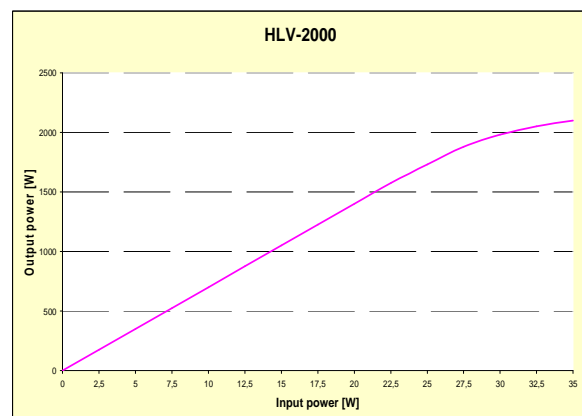

Output vs input

The following models are available:

- HLV-2000-10
- HLV-2000-20
- HLV-2000-30
- HLV-2000-45

The suffix indicates the RF drive level.

3. Safety instructions

Please be aware of the following before use:

1. **Caution!** This device is generating high frequency energy with high power which is highly dangerous in case of improper connection and use.
2. **Mains connection is only allowed to sockets including a rules compliant PE connection. Especially when operated at generators.**
3. This device is only permitted to be used by licensed radio amateurs or authorized skilled persons. Please take care of the license rules of your country.
4. The device is only permitted for use in the 144-148 MHz frequency range.
5. Operation is only permitted at temperatures between 5°C – 32°C or 40°F - 104°F and at humidity of less than 85%. In order to avoid malfunction caused by condensation you will have to wait at least one hour before start of operation and until the condensation has been removed.
6. To prevent electrical shock, do not remove the cover before disconnecting the mains plug.
7. The bottom openings are used as a cooling air inlet and the rear side outlet to exhaust the inside generated heat. They must not be covered!
8. Take care that the device is placed on a flat and stable base plate and is not subject to strong shocks and vibrations.
9. **This amplifier must not be operated with a 100% duty cycle at full output power.**
10. The device is sensitive to antenna mismatch of $> 1,8:1$. Operation with RF connectors left open or shortened or terminated exceeding a VSWR $> 1:1,8$ is not permitted and can cause damage to the RF power module.

4. Electrical connections

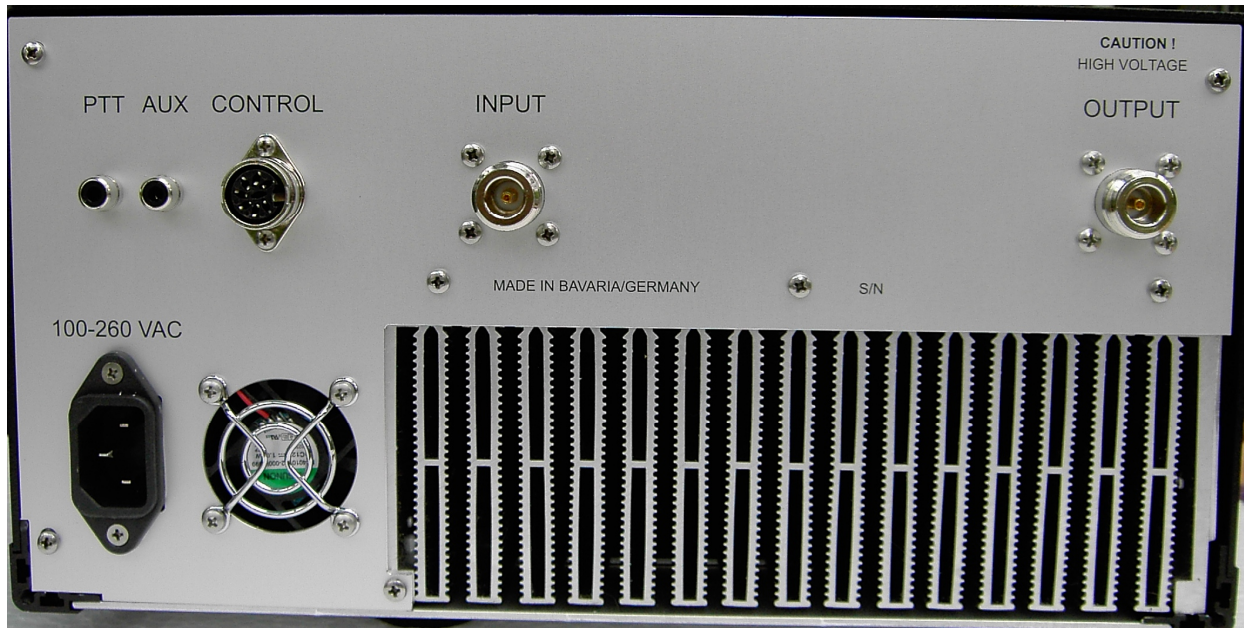

In order to guarantee trouble free operation you should observe the following instructions:

1. The device is only permitted for operation with mains voltages of 180 – 260 Volts AC and frequencies between 50 - 60 Hz. Operation at 100 – 130 VAC 50/60 Hz is generally possible but with lowered specifications.
2. Please use the mains cable enclosed or one of equal quality and power capability. For use in the US please cut off the German plug and connect it to your 220 V socket.
3. In case of connection to an AC power generator, you must check if the required specifications under item 1 especially under full load conditions are fulfilled. Ignoring the above can cause damage and will exclude warranty.
4. The system impedance of the device is 50 Ohms. In order to achieve optimum driving level and maximum output power, all load and source impedances should also be 50 Ohms. Deviations will automatically cause limitation of the specifications and shifting of the threshold voltages of the protection circuits. Operation with no load connected is not allowed.
5. The RF connectors are N-type. Only high quality connectors with PTFE insulation must be used. Neglecting will cause overload and damage of the connectors and shifting of the thresholds of the protection circuits. Special care must be taken when connecting the output cable to the output connector. If large and stiff low loss cables are used a short and flexible cable/adaptor solution must be interconnected. Otherwise too much bending force will be applied to the rear panel and to the female N-jack. This jack is part of the inside coaxial relay. When fastening any N-plug to this N-jack the use of a plyers or a similar tool must not be used!! Only strong finger tight fastening is allowed.

6. Switching the amplifier to transmit mode is accomplished via the PTT jack . Connect a single wire cable of up to 100 m length to the center pin. of the 5-pin A DC path to ground of < 100 Ohm or a voltage < 0,5 Volt is sufficient to switch the amplifier to transmit mode. It's important to have a common ground connection between the transceiver and the amplifier.

5. Warranty

Congratulations for purchasing a BEKO power amplifier. This solid state device uses the latest circuit design techniques and features high quality “Made in Germany” precision assembly. This unit meets the latest CE conformity and FCC rules.

We grant a 2 years warranty including parts and labour beginning from the date of purchase.

Unauthorized use or improper handling will invalidate all claims on warranty.

**The device is protected by an invisible seal against opening.
Damage of the seal will invalidate the warranty.**

Warranty is also excluded if damages are caused by :

1. Overdrive with power levels >75W or with power peaks caused by insufficient ALC control of the driving source.
2. Feedback oscillations due to direct radiation caused by too small distance between antenna and amplifier (<3m)
3. Applying frequencies out of band.
4. Readjustment of the trimpots for protection levels
5. Opening of the inside shielded RF block
6. Damage of the N-connectors due to use of non conforming parts

6. Front panel operation



POWER

After switching the “**POWER**”-switch to ON, the amplifier will be turned on. This is indicated by the green “**ON**”-LED. It takes approx. 5 seconds until the internal supply voltage rises up to 50 VDC and releases PTT operation. The HLV-2000 has an integrated pfc-controlled switched power supply with an efficiency of > 96%. The total mains power consumption @ 2.000 watts into a 50 ohms load is <2.900 watts.

PREAMP

When pressing this switch to ON, the integrated sequencer enables trouble free operation with external high quality pre amplifiers This is confirmed by the illuminated yellow “Preamp”-LED. This sequencer control circuit activates the RF-power unit after turning off the preamplifier. When returning to receive, it turns the preamplifier on after switching off the RF-power unit. The supply voltage for the use of an external preamplifier is available on pin 4 of the “CONTROL”-jack at the rear panel. It is short circuit protected by use of a ptc-fuse and supplies 15 volts/ 750 mA. Preamps that only can accept voltage feed via the coaxial cable, can't be used with this amplifier.

STANDBY

If the “**STANDBY**”-switch is pushed, the RF-unit is turned off while keeping the amplifier still turned on but with an RF bypass condition from input to output. This condition is indicated by the illuminated yellow “**PAOFF**”-LED. While in STANDBY, the sequencer and preamp control (If the preamp switch is ON) functions of the amplifier continue to operate normally. When the PTT line of the amplifier is grounded, the preamp voltage will be dropped and the AUX jack will go to ground.

RESET

The HLV-2000 operation is internally monitored by many highly efficient protection circuits. If any limit is exceeded the device shuts off. If any protection circuit is activated the red “**PROTECTION**”-LED illuminates as well as one of the three protection circuit LEDs “**ANTENNA**”, “**OVERDRIVE**” or “**TEMPERATURE**”. At the same time, an acoustic signal sounds. The internal beeper can be switched off when not needed. Access to the micro switch is through the 17th air gap in base plate in the near of the Standby switch. An alarm signal of 5V DC is fed to Pin 1 of the “**CONTROL**”-jack for any monitoring purpose. To turn the amplifier on again the “**RESET**”-switch must be turned off for a short time and then on again.

Attention: Please insure that the amplifier is disconnected from the mains when disabling the audible alarm.

7. Protection circuits

The HLV-2000’s internal control circuit supervises the output load condition, any overdrive of the input stage and the thermal status of heat sink and power supply unit. If the amount of reflected power exceeds 100 watts, the protection circuit shuts off the RF unit immediately and switches the drive power to bypass mode. This also happens with overdrive levels of more than 15% of the rated value or when overheating the amplifier by >55°C or 130°F.

CAUTION

This amplifier uses a new and ultra fast overdrive detection for cutting off all kinds of alc overshoot and spikes >3 db of rated input level coming from the transceivers used . Input levels up to 150 watts are kept away from the expensive rf transistor’s input. Although the internal protection circuits are very efficient they cannot assure a 100% safety. Direct radiation due to too small a distance between the antenna and the amplifier can cause feedback effects or falseing of the threshold levels of the protection circuits.

8. Transmit operation

The RX/TX-switching is activated by applying zero volts or ground to the “PTT” or pin 6 of the “CONTROL”-jack on the rear panel. This will be indicated by the illuminated green “PTT”-LED. On most transceivers, a ground on transmit will be supplied separately by an accessory output on their rear panel.

Both of the two internal coaxial relays are controlled with different time delays to allow for their specific switching times and to achieve zero power switching. The PTT line is also used to generate the bias voltage to run the MOSFETs in class AB. Without RF input the total idle current is 5 A, equivalent to dissipating 250 watts. An internal generated and delayed PTT- function is available at the inner contact of the rear sided “AUX“- jack to reliably control a connected transceiver. Any potential at the inner conductor is switched to ground.

In essence, your amplifier provides a built-in multi-level sequencer which provides an alternate means to key your radio last.

When the amplifier PTT is activated usually via a foot switch, the preamp voltage is dropped first, internal relays are switched, the RF amplifier section is turned on and finally via the AUX jack a ground on transmit is available to key your radio.

When using SSB you should not exceed 80% watts of input power to achieve best spectral purity with low inter-modulation distortion. A red LED indicator integrated in the front panel power meter indicates the 1 dB compression point limit at 1950 watts. Exceeding this limit will cause harmonic distortions to be transmitted. An integrated peak-hold function provides a more effective indication of the output power.

9. REMOTE control

This amplifier can also be remote controlled. RESET-, PREAMP- and PTT-function can easily be activated by an external switch wired to ground. Output power can be monitored. 100% of output power is equal to 10V DC on Pin 5. Use the 7-pin DIN plug that was delivered with your amplifier and connect the other end to a suitable connector to your transceiver or other switching unit.

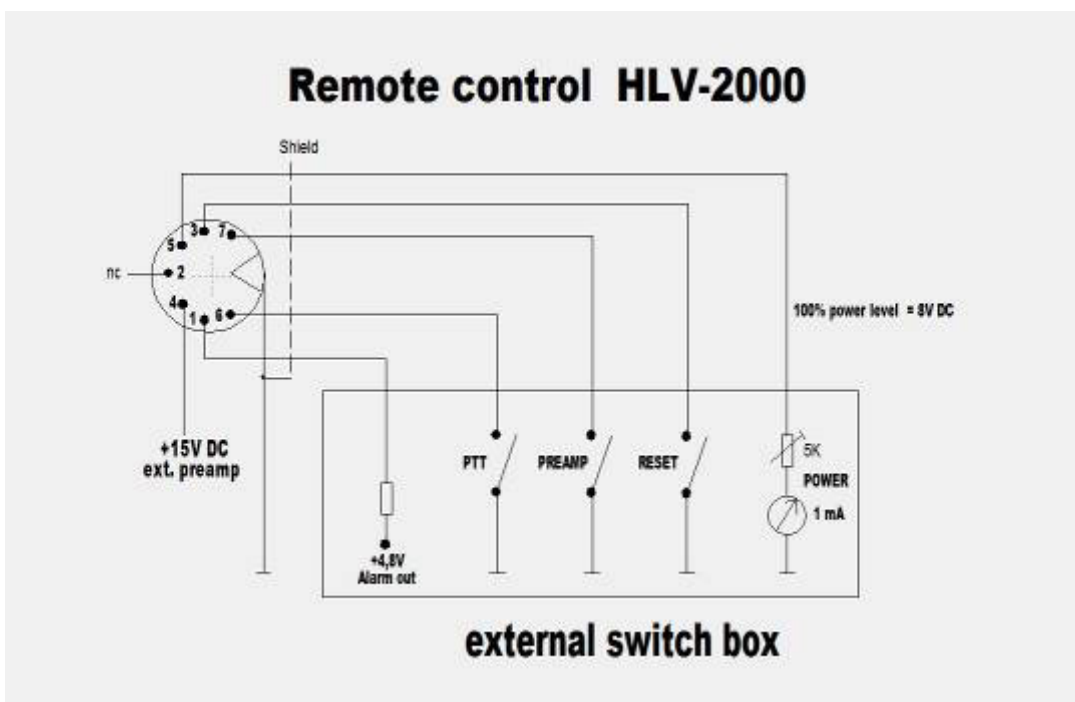

10. Cooling technique

The integrated axial blowers are temperature controlled and provide sufficient cooling during long time operation at full output power with minimum noise level. During the TX period the airflow through the RF box is increased by higher speed of the cavity blower which is noticeable by a slight noise increase. Especially during long term operation with MS or WSJT this is essential for avoiding rapid temperature rise of balun and output filter coils.

To achieve best airflow for cooling, the air in- and outlets must not be covered. Do not operate the amplifier in close proximity to heaters and radiators. If thermal shut down occurs you should wait until the device temperature decreases sufficiently before switching on the amplifier again. Please read also our “**Safety instructions**” and “**Electrical connections**”.

ATTENTION !

This device is not designed for 100% duty cycle at rated output power. Only an intermediate operation including a sufficient recovering time for cooling is permitted. Max. duration for a once non stop TX-period @30°C or 86°F is 5 minutes.

11. Block diagram

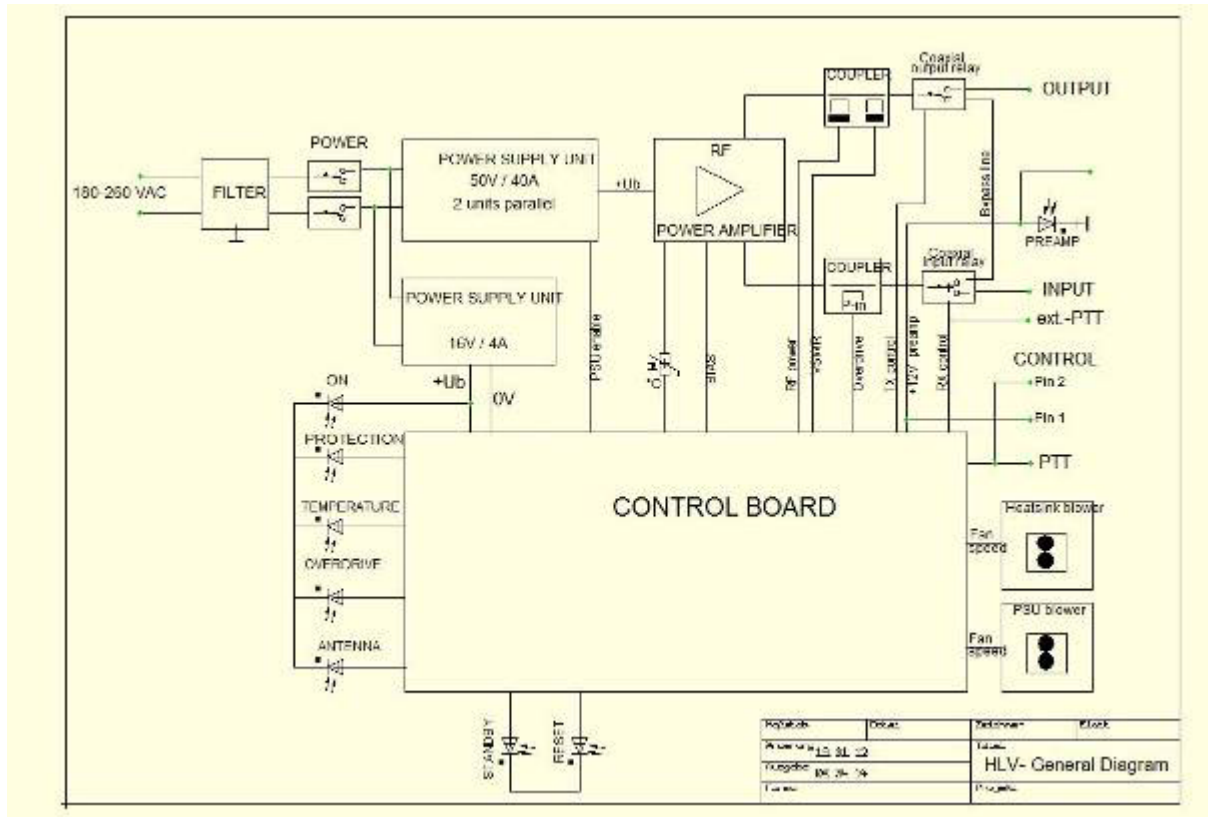

12. Adjustment of protection thresholds

In some cases the default adjustments are too sensitive and need some slight correction. In the picture below all trimpots incl. their functions are shown. Turning the slots clockwise is equal to + or upward direction and verse vice. Readjustment should be done very carefully otherwise the effect of protection is cancelled.

